

SELECT DESIRED HARDWOOD SIDING:

- IPE
- CUMARU
- MASSARANDUBA
- TIGERWOOD
- GARAPA

PAINTABLE ANODIZED ALUMINUM EXTRUSION OUTSIDE CORNER

MITERED CORNER JOINT

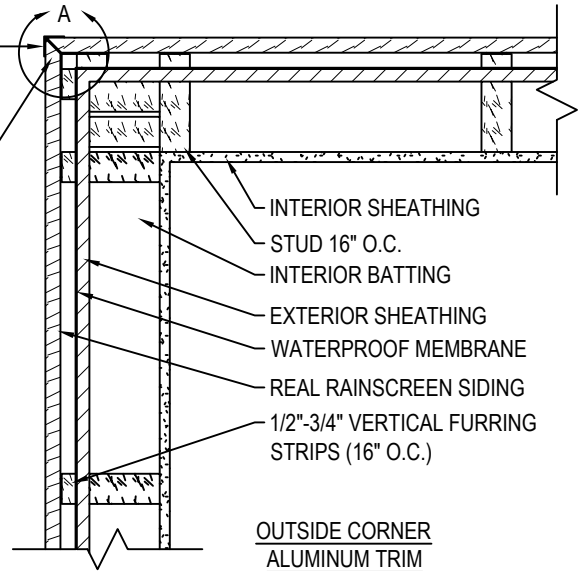

SELF-TAPPING SCREW
 #8 SQUARE DRIVE,
 599 MAGNI-COATED

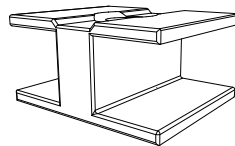
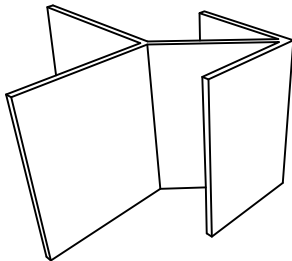

OVERLAPPED CORNER JOINT

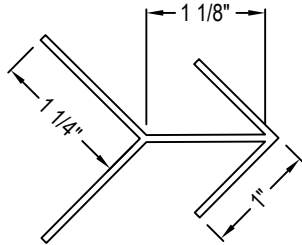
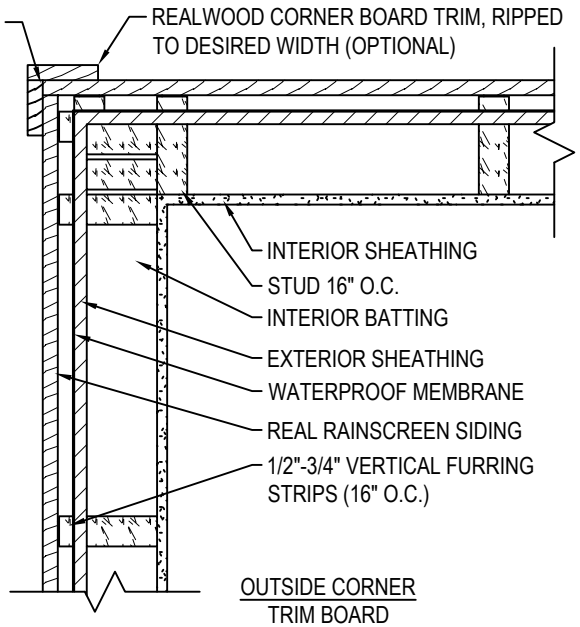

DETAIL A

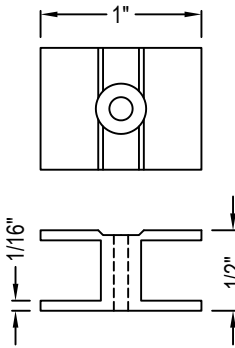

DETAIL
 ALUMINUM HIDDEN H-CLIP
 599 MAGNI-COATED

MANUFACTURER NOTES:

1. VERTICAL FURRING STRIPS CAN BE CENTER-RIPPED PRESSURE TREATED 1X4 OR FIRE RESISTANT (GRADE A) PVC (THERMAL BREAK).

NOTES:

1. INSTALLATION TO BE COMPLETED IN ACCORDANCE WITH MANUFACTURER'S SPECIFICATIONS.
2. DO NOT SCALE DRAWING.
3. THIS DRAWING IS INTENDED FOR USE BY ARCHITECTS, ENGINEERS, CONTRACTORS, CONSULTANTS AND DESIGN PROFESSIONALS FOR PLANNING PURPOSES ONLY. THIS DRAWING MAY NOT BE USED FOR CONSTRUCTION.
4. ALL INFORMATION CONTAINED HEREIN WAS CURRENT AT THE TIME OF DEVELOPMENT BUT MUST BE REVIEWED AND APPROVED BY THE PRODUCT MANUFACTURER TO BE CONSIDERED ACCURATE.
5. CONTRACTOR'S NOTE: FOR PRODUCT AND COMPANY INFORMATION VISIT www.CADdetails.com/info AND ENTER REFERENCE NUMBER 5376-002.

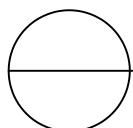

REAL RAINSCREEN SIDING (FOR WOOD STUDS)

OUTSIDE CORNER DETAIL